

Level control relay YCL8 Instruction Manual

General



- Applications
 - Designed for monitoring level in wells, basins, reservoirs, tanks.....
- Function Features
 - In one device you can choose the following configurations:
 - 2 level control mode
 - 1 level control mode
 - Choice of function PUMP UP, PUMP DOWN.
 - Adjustable time delay on the output (0.1 - 10s).
 - Sensitivity adjustable by a potentiometer (5-100kΩ).
 - Galvanically separated supply voltage AC/DC 24-240V.
 - Relay status is indicated by LED.
 - 1-MODULE, DIN rail mounting.

■ Model and connotation

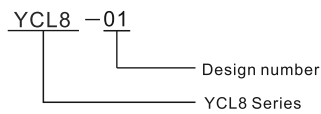

Technical parameters

Technical parameters	YCL8-01	YCL8-02
Function	2 level control mode	2 or 1 level control mode
Supply terminals	A1-A2	
Voltage range	AC/DC 24-240V(50-60Hz)	
Input	max.2VA	
Supply voltage tolerance	-15%;+10%	
Sensitivity (input resistance)	adjustable in range 5 kΩ - 100 kΩ	
Voltage in electrodes	max. AC 5 V	
Current in probe	AC <0.1 mA	
Time response	max. 400 ms	
Max. capacity length	800 m (sensitivity 25kΩ), 200 m (sensitivity 100 kΩ)	
Max. capacity of probe cable	400 nF (sensitivity 25kΩ), 100 nF (sensitivity 100 kΩ)	
Time delay (t)	adjustable, 0.1 - 10 s	
Accuracy in setting (mechanical)	±10 %	
Temperature coefficient	0.05%/°C, at=20°C(0.05%/°F, at=68°F)	
Output	1×SPDT	
Current rating	10A/AC1	
Switching voltage	250VAC/24VDC	
Min. breaking capacity DC	500mW	
Output indication	red LED	
Mechanical life	1×10 ⁷	
Electrical life(AC1)	1×10 ⁵	
Reset time	max.200ms	
Operating temperature	-20°C to +55°C (-4°F to 131°F)	
Storage temperature	-35°C to +75°C (-22°F to 158°F)	
Mounting/DIN rail	Din rail EN/IEC 60715	
Protection degree	IP40 for front panel/IP20 terminals	
Operating position	any	
Overvoltage category	III.	
Pollution degree	2	
Max. cable size(mm ²)	solid wire max.1×2.5or 2×1.5/with sleeve max.1×2.5(AWG 12)	
Tightening torque	0.8Nm	
Dimensions	90×18×64mm	
Weight	70g	72g
Standards	EN 62055-1	

Panel Diagram

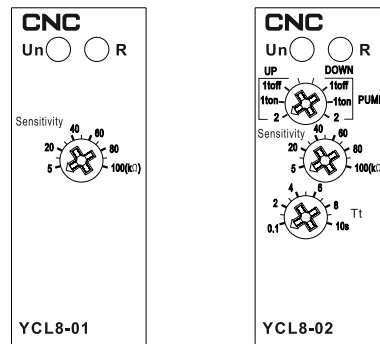

Wiring Diagram

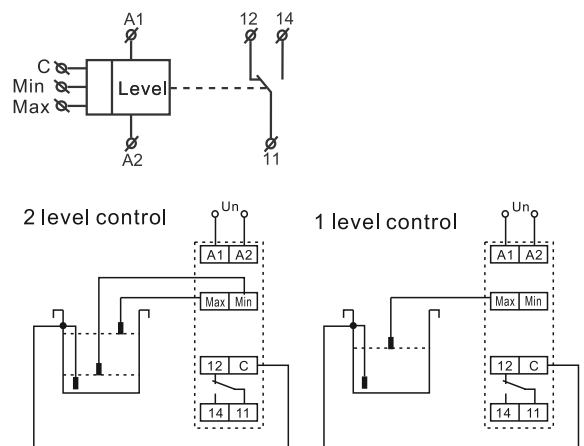

Functions Diagram

YCL8-01 2 level control

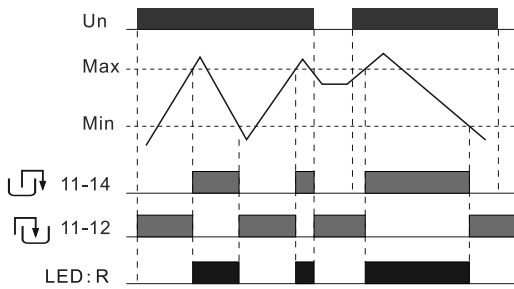

YCL8-02

2 level control(pump up/down)

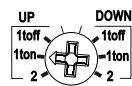
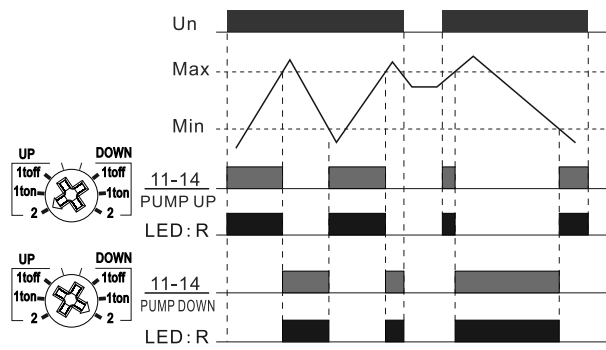

1 level control(pump up t on)

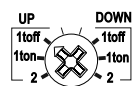
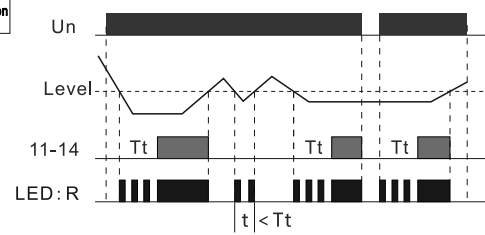

1 level control(pump up t off)

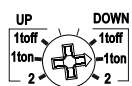
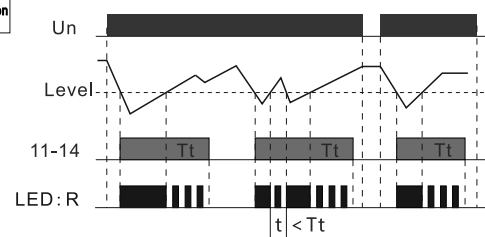

1 level control(pump down t on)

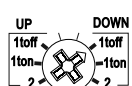
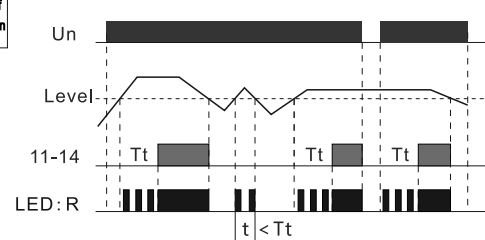

1 level control(pump down t off)

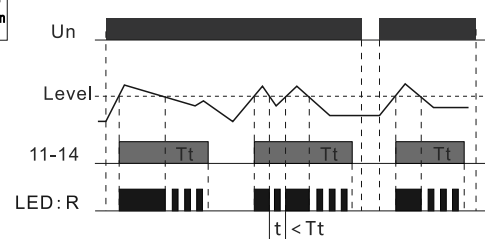

Dimensions(mm)

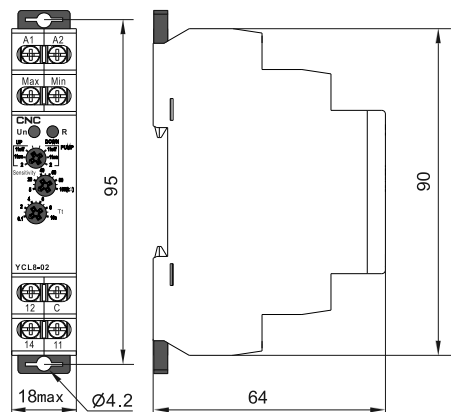

Disposal of Electrical Waste
All electrical waste should be disposed of in compliance with current WEEE regulations.



Caution
The products must be installed by qualified electricians. All and any electrical connections of the product shall comply with the appropriate safety standards.